

Wireless Based the Patient Monitoring System Using IoT

¹Asst Prof. S. Bhanu Sireesha, ²K. Navya shree, ³K. Tejeswi, ⁴S. Durga reddy,
⁵K. Rasi, ⁶P. Hemanth

^{1, 2, 3, 4, 5, 6} Department of Electronics and Communication Engineering, Lingayas Institute of Management and Technology,
Via Nunna, Krishna District, AP, India

Abstract: These days we have an increased number of heart diseases including increased risk of heart attacks. Our proposed system uses sensors that allow to detect heart rate of a person using heartbeat sensing even if the person is at home. The sensor is then interfaced to a microcontroller that allows checking heart rate readings and transmitting them over internet. The user may set the high as well as low levels of heart beat limit. After setting these limits, the system starts monitoring and as soon as patient heart beat goes above a certain limit, the system sends an alert to the controller which then transmits this over the internet and alerts the doctors as well as concerned users. Also the system alerts for lower heartbeats. Whenever the user logs on for monitoring, the system also displays the live heart rate of the patient. Thus concerned ones may monitor heart rate as well get an alert of heart attack to the patient immediately from anywhere and the person can be saved on time.

Keywords: Node MCU, Internet of Things, Cloud Computing, Heart rate sensor, Body temp sensor, Android, Buzzer.

1. INTRODUCTION

A Wireless health monitoring system is an extension of a hospital medical system where a patient's vital body state can be monitored remotely. Traditionally the detection systems were only found in hospitals and were characterized by huge and complex circuitry which required high power consumption [1-2]. Continuous advances in the semiconductor technology industry have led to sensors and microcontrollers that are smaller in size, faster in operation, low in power consumption and affordable in cost. This has further seen development in the remote monitoring of vital life signs of patients especially the elderly. The wireless health monitoring system can be applied in the following scenarios [3-4]:

1. A patient is known to have a medical condition with unstable regulatory body system. This is in cases where a new drug is being introduced to a patient [5].
2. A patient is prone to heart attacks or may have suffered one before. The vitals may be monitored to predict and alert in advance any indication of the body status [6].
3. Critical body organ situation [7].
4. The situation leading to the development of a risky life-threatening condition. This is for people at an advanced age and maybe having failing health conditions [8].
5. Athletes during training. To know which training regimes will produce better results [9].

In recent times, several systems have come up to address the issue of wireless health monitoring. The systems have a wireless detection system that sends the sensor information

wirelessly to a server. Some even adopted a service model that requires one to pay a subscription fee. In developing countries, this is a hindrance as some people cannot use them due to cost issue involved. There is also the issue of internet connectivity where some systems to operate, good quality internet for a real-time wireless connection is required. Internet

penetration is still a problem in developing countries. Many of the systems were introduced in the developed countries where the infrastructure is working perfectly. In most cases, the systems are adapted to work in developing countries. To reduce some of these problems there is need to approach the wireless detection from a ground-up approach to suit the basic minimal conditions presently available in developing countries. A simple patient monitoring system design can be approached by the number of parameters it can detect. In some instances, by detecting one parameter several readings can be calculated. For simplicity considerations parameter detection are:

i) Single parameter monitoring system:

In this instance, a single parameter is monitored e.g. Electrocardiogram (ECG) reading. From the ECG or heartbeat detection, several readings can be got depending on the algorithm used. An ECG reading can give the heart rate and oxygen saturation [10].

ii) Multi-parameter monitoring system:

This has multiple parameters being monitored at the same time. An example of such a system can be found in High Dependency Units (HDU), Intensive Care Units (ICU), during the surgery at a hospital theatre or Post surgery recovery units in Hospitals. Several parameters that are monitored include the ECG, blood pressure, respiration rate. The Multi-parameter monitoring system basically proof that a patient is alive or recovering. In developing countries, just after retiring from their daily career routine majority of the elderly age group, move to the rural areas. In developed countries, they may move to assisted living group homes. This is where a wireless health monitoring system can come in handy [11-12].

2. METHODOLOGY

In hospitals there are provisions for continuous monitoring of patients. Their heartbeats are continuously monitored. There is no provision to check the parameters when they return to home. And hence there is a chance that the disease may return again. Patient's data (temperature, heart rate, position) will be frequently measured and sent to server. Period of sending (say every 3 min) can be set. Monitoring person learns patient specific threshold. Say the regular body temperature of a patient is 37°C whereas one person feels feverish if his body temperature is 37°C. By employing an averaging technique over a relatively long time, Observer can learn these thresholds for patients. Using Android Application in doctor's smart phone, doctor can view his patient's health status. When any of the parameter goes beyond the threshold value he will get an alert notification. Using Android Application in patient's or his caretaker's smart phone the patient can view his health status.

3. BLOCK DIAGRAM

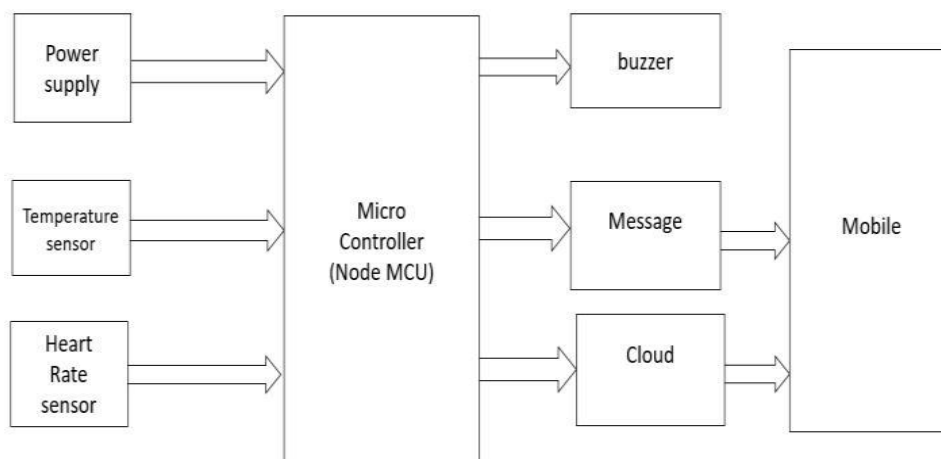

Fig 1: Block diagram of patient monitoring system using IoT

Early detection and diagnosis of potentially fatal physiological conditions such as heart attack require continuous monitoring of patients health following transfer from hospital to home. Studies have shown that 30% of patients with a discharge diagnosis of heart failure are Readmitted at least once within 90 days with readmission rates ranging from 25 to 54% within 3 – 6 months. In response to these types of needs, health monitoring systems are being proposed as a low cost solution. Such a system consists of physiological data that stores, process and communicate through a local manner such as smart phones, personal computers. Such systems should satisfy strict safety, security, reliability, and long-term real-time operation requirements. In the proposed system we present a health monitoring system that uses the sensors for collecting data from patients, intelligently predicts patient's health status and provides feedback to doctors through their mobile devices having android application.

The patients will participate in the health care process by their mobile devices and thus can access their health information from anywhere any time. Today Internet has become one of the important part of our daily life. It has changed how people live, work, play and learn. Internet serves for many purpose educations, finance, Business, Industries, Entertainment, Social Networking, Shopping, E-Commerce etc. The next new mega trend of Internet is Internet of Things (IOT). Visualizing a world where several objects can sense, communicate and share information over a Private Internet Protocol (IP) or Public Networks. The interconnected objects collect the data at regular intervals, analyse and used to initiate required action, providing an intelligent network for analyzing, planning and decision making.

This is the world of the Internet of Things (IOT). The IOT is generally considered as connecting objects to the Internet and using that connection for control of those objects or remote monitoring. But this definition was referred only to part of IOT evolution considering the machine to machine market today. But actual definition of IOT is creating a brilliant, invisible network which can be sensed, controlled and programmed. The products developed based on IOT include embedded technology which allows them to exchange information, with each other or the Internet and it is assessed that about 8 to 50 billion devices will be connected by 2020. Since these devices come online, they provide better life style, create safe and more engaged communities and revolutionized healthcare. The entire concept of IOT stands on sensors, gateway and wireless network which enable users to communicate and access the application/information.

FLOW CHART

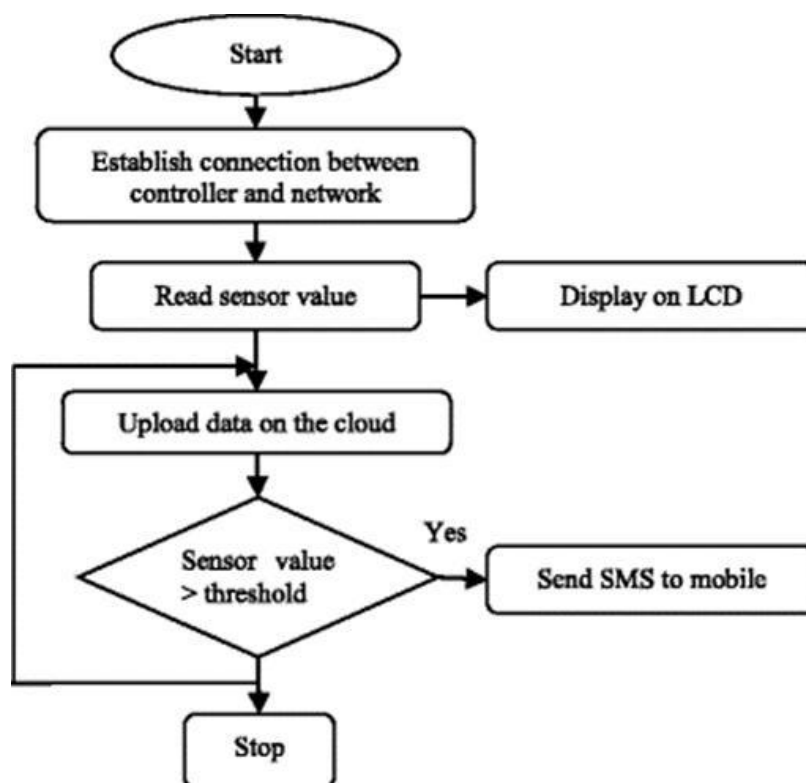

Fig 2: Flow chart of patient monitoring system using IoT

Circuit diagram

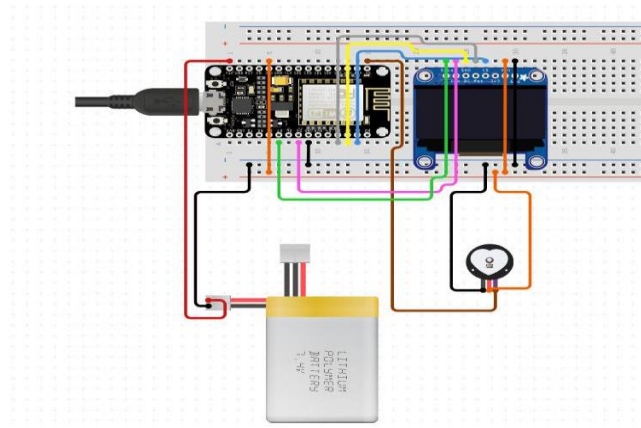

Fig 3: Circuit diagram of patient monitoring system using IoT

In this we are using nodemcu micro controller, LCD display and two sensors (temperature, pulse rate sensor), buzzer. The coding source is dumping in the nodemcu by using usb cable. Buzzer is used to indicate whether the patient condition is in danger or not.

COMPONENTS

➤ Hardware Components

1. Node MCU
2. LCD
3. Buzzer

➤ Software

1. Embedded C program

➤ Sensors

1. Heart rate (analog)
2. Temperature (digital)

NODE MCU

Node MCU is an open source IoT platform. It includes firmware which runs on the ESP8266 Wi-Fi soc from Espressif Systems, and hardware which is based on the ESP-12 module. The term "Node MCU" by default refers to the firmware rather than the development kits. The firmware uses the Lua scripting language. It is based on the eLua project, and built on the Espressif Non-OS SDK for ESP8266. It uses many open source projects, such as lua-cjson and SPIFFS.



Fig 4: Node MCU

Embedded C Programming

- Embedded C is a set of language extensions for the C programming languages by the C languages committee to address commonality issues that exists in between C extensions for different embedded system.
- It includes number of features not available in normal C such as fixed point arithmetic named address spaces and basic I/O hardware addressing.

Heart Rate Sensor

The heartbeat sensor is based on the principle of photo plethysmography. It measures the change in volume of blood through any organ of the body which causes a change in the light intensity through that organ (a vascular region). In case of applications where heart pulse rate is to be monitored, the timing of the pulses is more important. The flow of blood volume is decided by the rate of heart pulses and since light is absorbed by blood, the signal pulses are equivalent to the heart beat pulses.

Temperature Sensor

Temperature Sensors measure the amount of heat energy or even coldness that is generated by an object or system, allowing us to “sense” or detect any physical change to that temperature producing either an analogue or digital output. There are many different

Types of Temperature Sensor

Available and all have different characteristics depending upon their actual application.

LCD (Liquid Crystal Display)

It is a combination of two states of matter solid and liquid. It is used as a liquid crystal to produce a visible image. It is mainly composed of two polarized panel filters and electrodes.

It is either made up of an active matrix or passive display grid. It works on the principle of blocking light. When electric current is LC molecule it causes angle of light passing through polarized glass that particular area will become dark. When there is no current then light passes through front of LCD it will be reflected by mirror and bounces back.

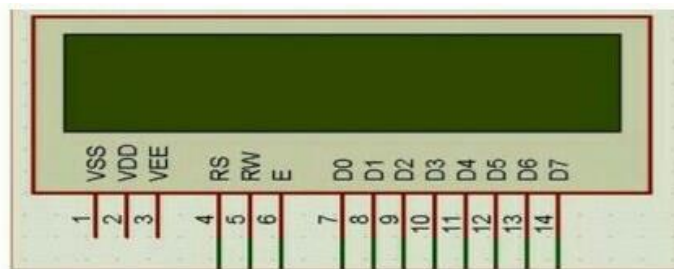

Fig 5: LCD Display

4. WORKING

There are mainly two parts of the system one is transmitter and the other one is the receiver. In the transmitter, We have Heartbeat sensor and the temperature sensor. All the sensors are connected to the patient. The microcontroller monitors the all the system in the transmitter if any abnormality in the patient condition then it sends the signal so that the receiver will capture the signal and will work according to that.

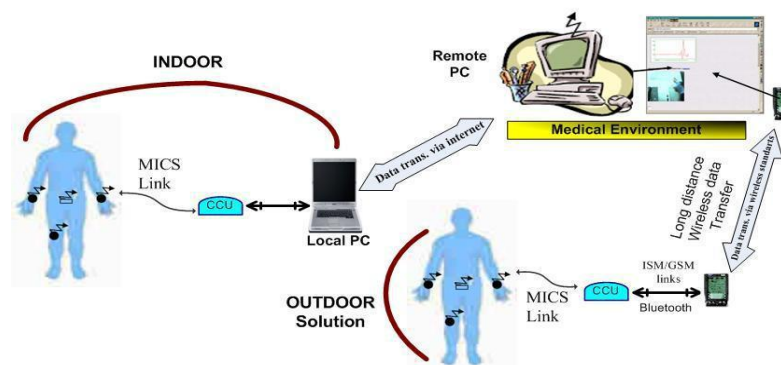

Fig 6: Working process of patient monitoring system using IoT

5. RESULT

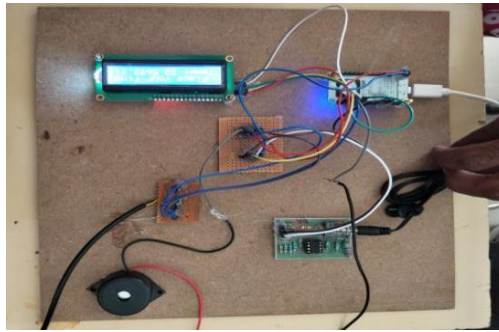

Fig 7: Presenting the wireless patient monitoring system using IoT

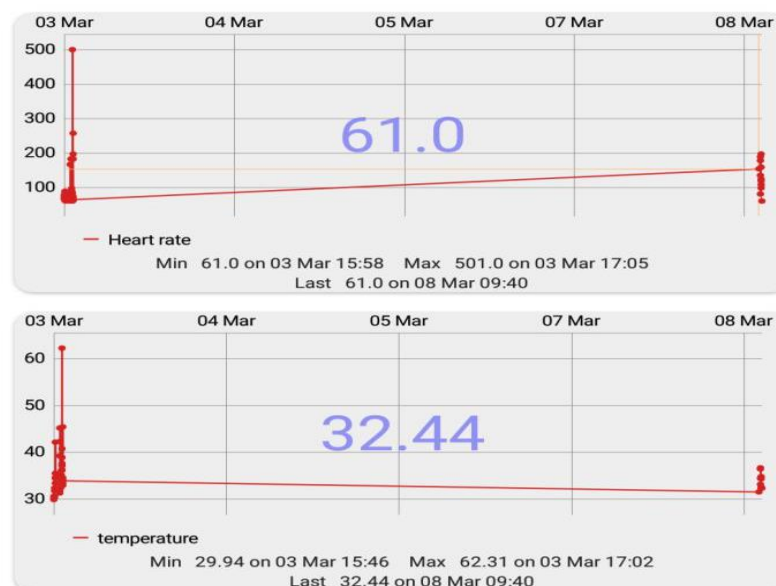

Fig 8: Output waveforms

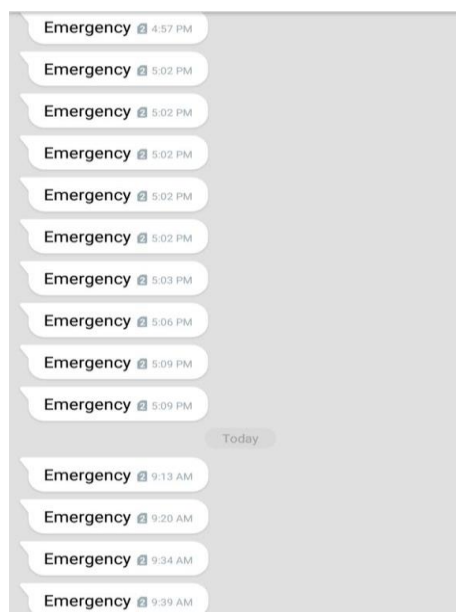

Fig 9: Alert messages in mobile

6. CONCLUSION

In this study, the Wireless Patient Monitoring System has monitored the patient condition especially the heart beat easily and also increases the efficiency of patient data monitoring. The data successfully transmitted wirelessly to the receiver and display the data at the PC. All the hardware design, data communication between hardware and software, wireless communication and GUI for the whole system is successfully function and can be used as a wireless patient monitoring system using IOT as to replace the usage of Bluetooth and SMS through GSM as the communication tool.

7. FUTURE SCOPE

Multiple parameters like blood pressure, retinal size, age and weight can be included as controlling parameters in the future.

This system is also developed by using Bluetooth technology in future.

ACKNOWLEDGEMENT

We gratefully acknowledge MR. UMASHANKAR The Head of Department of Electronics and communication Engineering for Extending the support.

REFERENCES

- [1] [http://www.bharian.com.my/bharian/articles/Sat udoktor untuk400pesakitpada2020/Article/](http://www.bharian.com.my/bharian/articles/Sat%20udoktor%20untuk%20400pesakitpada2020/Article/)
- [2] B. Priya, S.Rajendran, R. Bala and Gobbi, "Remote Wireless Health Monitoring Systems", in Conference on Innovative Technologies In Intelligent Systems and Industrial Application, 2009.
- [3] Ashwin K. Whitchurch, Jose K. Abraham, and Vijay K. Varadan, Member, IEEE. "Design and Development of a wireless remote point-of-care patient monitoring system", in High Density Electronic Center, University of Arkansas, Fayetteville.
- [4] Xiaoxin Xu Mingguang Wu, Cheng Ding and Bin Sun Jiangwei Zhang, "Outdoor Wireless Healthcare Monitoring System for Hospital Patients based on Zigbee" publish from Department of Control Science & Engineering, Zhejiang University Hangzhou, CHINA.
- [5] Lew C. K. and M. Moghavvemi, "Remote Heart Rate Monitoring System Based on Electrocardiography" 2002 Student Conference on Research and Development Proceedings, Shah Alam, Malaysia, 2002
- [6] Hassinen Marko, Marttila-Kontio Maija "Wireless System for Patient Home Monitoring", Department of Computer Science University of Kuipio, Kuipio, Finland.
- [7] http://www.microcontrollerboard.com/pic_memory_organization.html, "PIC 16F87XA Memory Organization Tutorial"
- [8] ww1.microchip.com/downloads/en/DeviceDoc/39582b.pdf, "MICROCHIP PIC16F87XA Data Sheet, 28/40/44-Pin Enhanced Flash Microcontrollers", 2008
- [9] Pin Enhanced Flash Microcontrollers", 2008
- [10] N. M. Z. Hashim, A. S. Jaafar, N. A. Ali, L. Salahuddin,
- [11] N. R. Mohamad, "Traffic Light Control System for Emergency Vehicles Using Radio Frequency", IOSR Journal of Engineering (IOSRJEN) Vol. 3, Issue 7, pp 43-52, 2013.
- [12] N. M. Z. Hashim, N. A. Ali, A. S. Jaafar, N. R. Mohamad, L. Salahuddin, N. A. Ishak, "Smart Ordering System via Bluetooth", International Journal of Computer Trends and Technology (IJCTT) – volume 4 Issue 7, pp. 2253-2256, 2010.